

# BETA

Anodized aluminium 6060 extruded profile with 45° light output, compatible with surface mounting on flat surfaces. Extremely easy to install, thanks to the fixing clips, the snap-in diffuser, and the flush-mounted side supports. Required for the correct dissipation of LED strips, and recommended for panel, under-wall cupboard, shelf and display case lighting.

 EXTRUDED IN ITALY

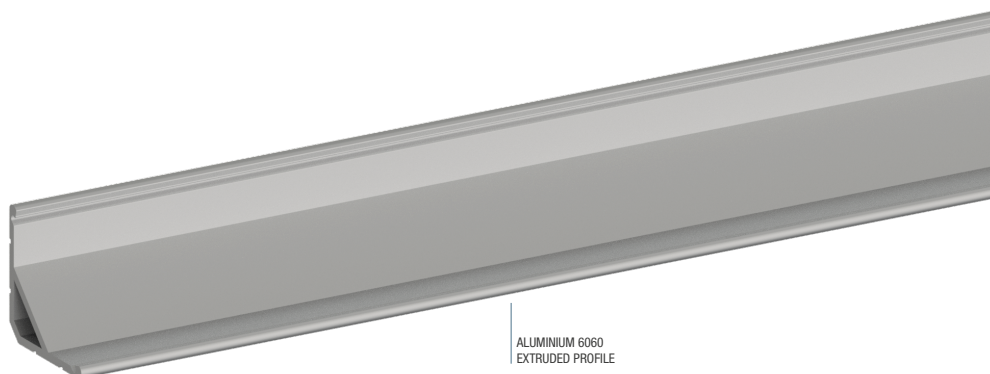

1:1 SCALE

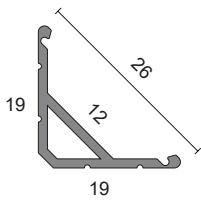

BASIC CODES

## PA.BETA.

LENGTH

- 1 1000mm
- 2 2000mm
- 3 3000mm

FINISHES

- 1 Matt white RAL9003
- 2 Matt black RAL9005
- 7 Brushed aluminium

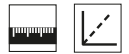

1.2

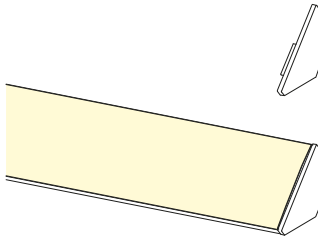

BASIC CODES

## SB01.

FINISHES

- 1 White
- 2 Matt black
- 5 Grey
- 7 Brushed aluminium

Side ABS closing support. Easy and quick to install, by exerting a slight side pressure.

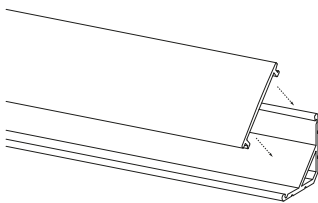

BASIC CODES

## PA.26PE04.

LENGTH

- 1 1000mm brushed
- 2 2000mm brushed
- 3 3000mm brushed

Brushed snap-on diffuser. The diffuser can be easily removed for maintenance operations.

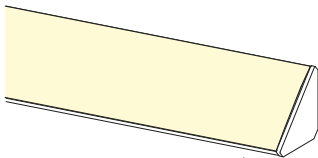

BASIC CODES

## SB02.8

Transparent polycarbonate clip with 12xM2.5 screw for surface mounting.

NB. We recommend No. 1 Clip per 500mm

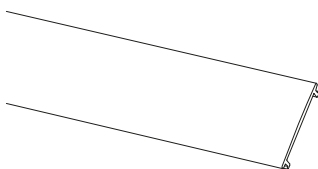

BASIC CODES

## TC02

Rectangular electronic device with ON/OFF TOUCH system. The LED can be switched ON/OFF by gently touching the sensitive device section. To be installed inside the profile, in contact with the diffuser, with the double-sided tape supplied (12Vdc and 24Vdc 4A max.)

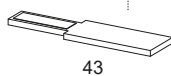

Code example: BETA Profile + 1000mm Length + Brushed Aluminium Finish = Code: PA.BETA.17